

BATHROOM

2022 / 2023



COLLECTIONS

PROGETTO IDEA STELLA

LAUNDRY



PROGETTO IDEA STELLA

BATHROOM COLLECTIONS 2022 / 2023

LAUNDRY
Solution **190**





PROGETTO IDEA STELLA



LAUNDRY

Solution

Lavabi in ceramica
 Ceramic countertop basins
 Keramikbecken
 Vasque en céramique

Bianco lucido



Rovere Nodato



Cemento



Bco Matrix



Lavabo 60

Ceramic countertop basins
 Keramikbecken
 Vasque en céramique

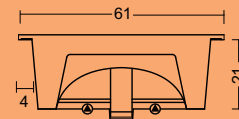
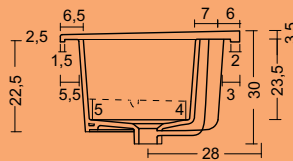
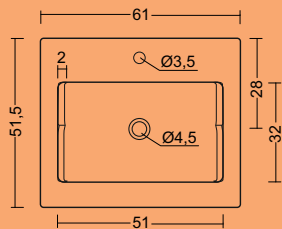



LAUNDRY 02 - rovere/cemento



LAUNDRY 01 - rovere/bianco larice

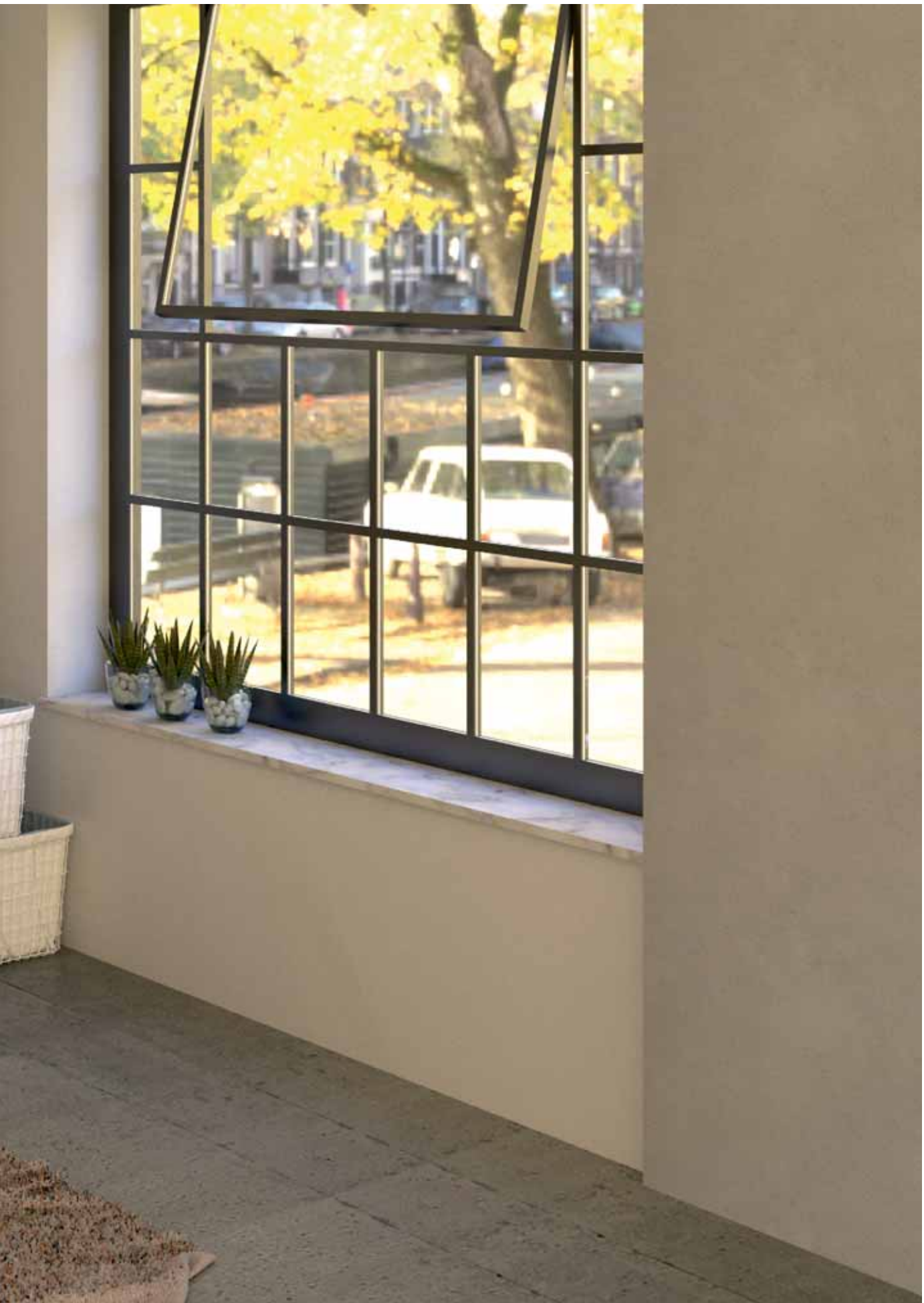

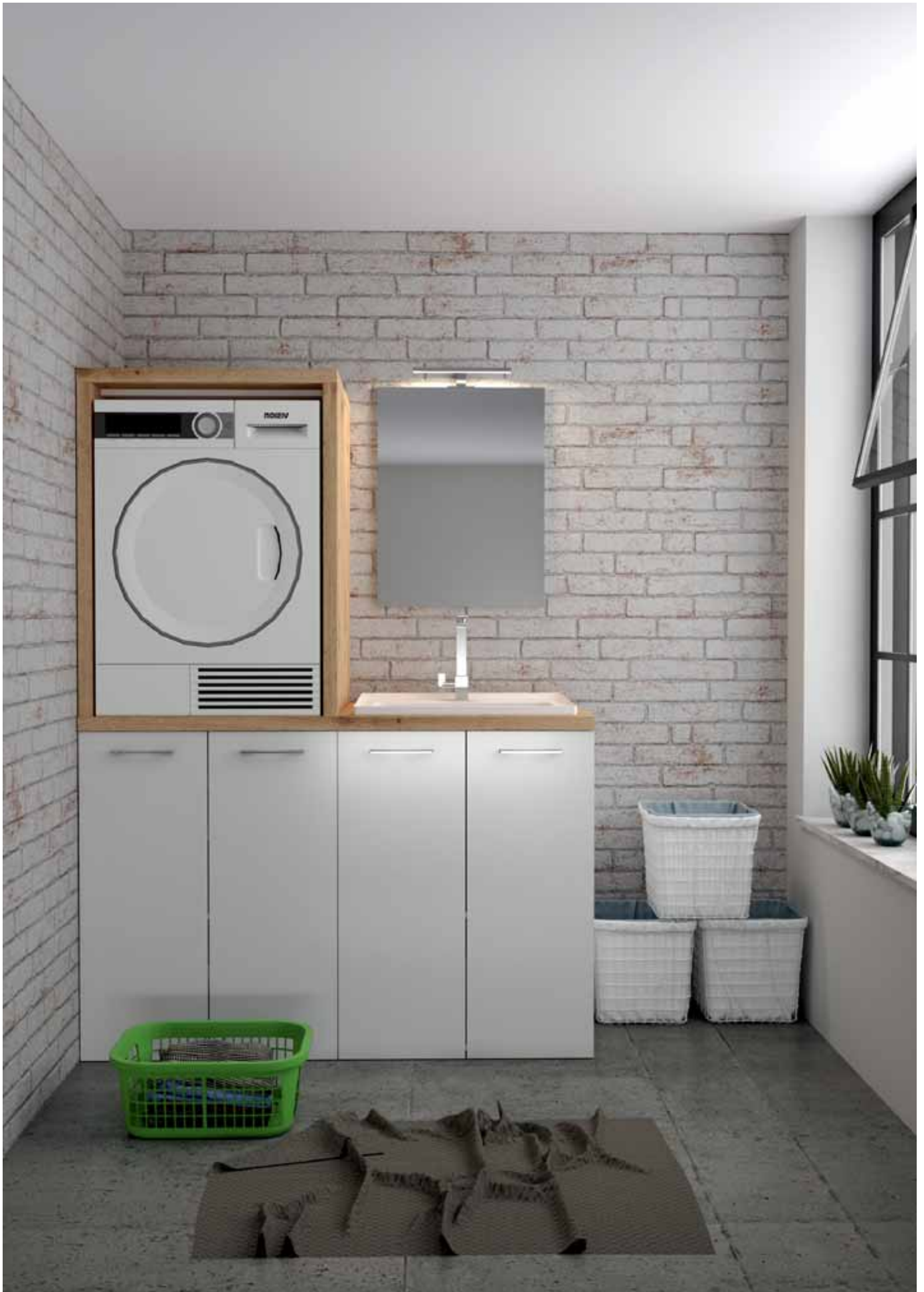

LAUNDRY 03 - rovere/bianco

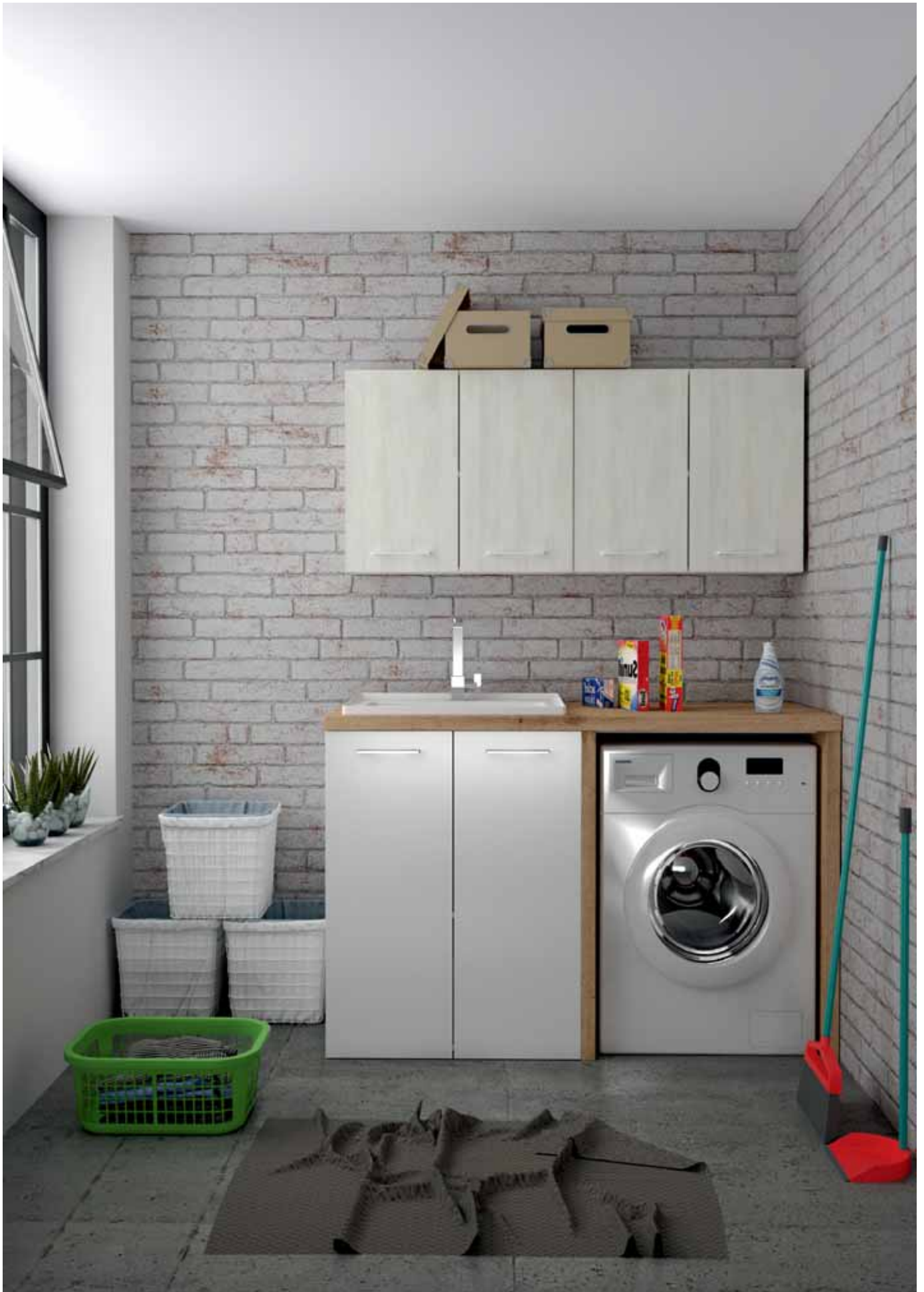

LAUNDRY 04 - rovere/bianco/bco matrix

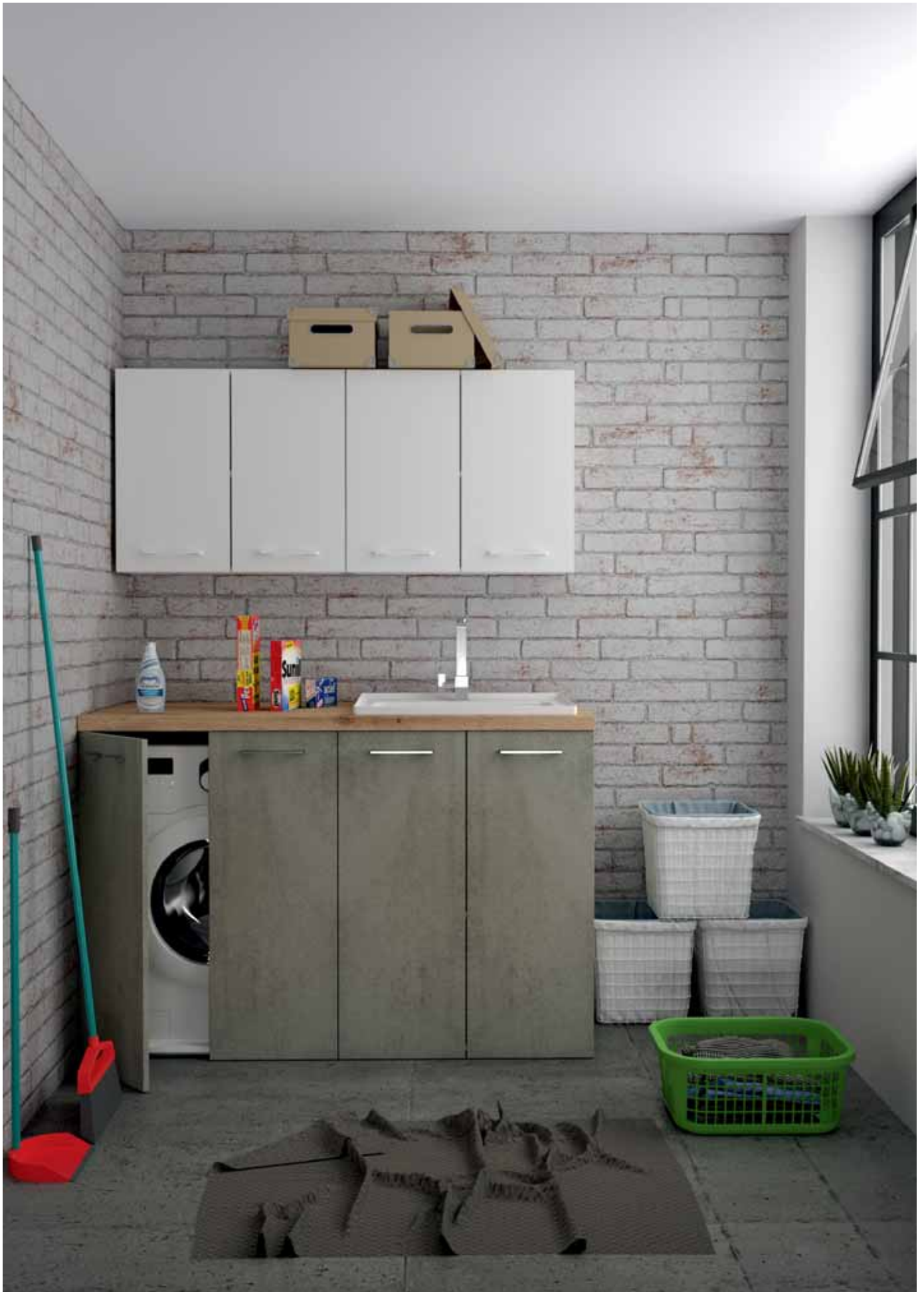

LAUNDRY 05 - rovere/cemento/bianco

LAUNDRY

Solution

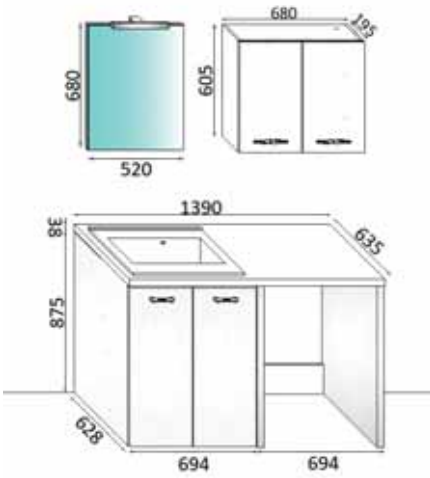

Laundry 01

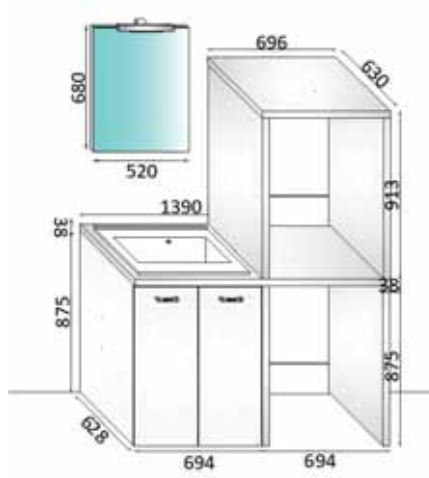

Laundry 02

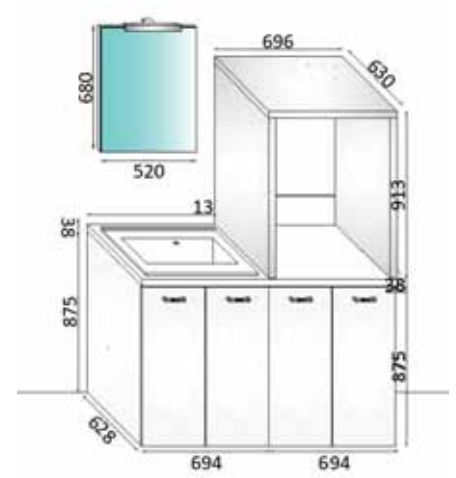

Laundry 03

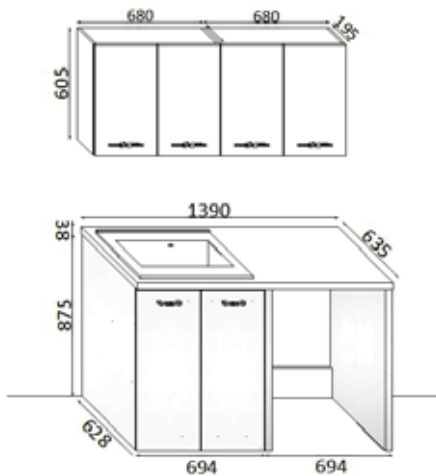

Laundry 04

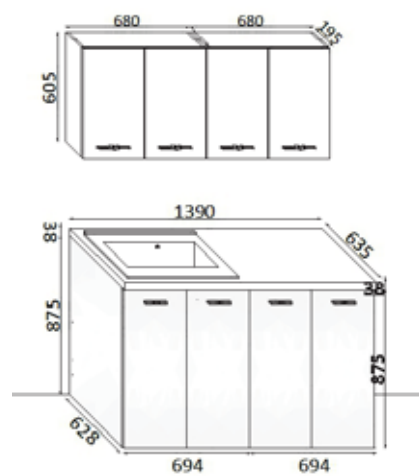

Laundry 05







Listino
Price List
Preisliste
Liste des Prix

LAUNDRY

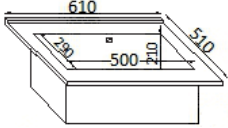

Colori - colours - Farben - couleurs

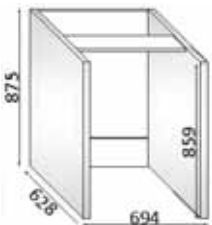
Ⓛ	Bianco	Bianco Matrix	Rovere N.	Cemento
Ⓜ	White	White Matrix	Rovere N.	Cemento
Ⓝ	Weiss	Weiss Matrix	Rovere N.	Cemento
Ⓣ	Blanc	Blanc Matrix	Rovere N.	Cemento

	<p>LAVABO JOLLY 61X51 – CERAMICA CERAMIC BASIN JOLLY 61X51 KERAMIK-WASCHTISCH JOLLY 61X51 VASQUE EN CÉRAMIQUE JOLLY 61x51</p>	<p>Art. 08559</p>			
	<p>TOP LEGNO 139X63,5 – C/FORI – ROV NOD COUNTERTOP 139X63,5 WITH HOLE – KNOTTED OAK PLATTE 139X63,5 – MIT LOCH – ASTEICHE PLAN 139X63,5 AVEC TOU – NOUEUX CHÊNE</p>			<p>Art. 08697</p>	
	<p>BASE SIMPLY 70X36X88 2/A CABINET SIMPLY 70X68X88 2/DOORS WASCHTISCHUNTERSCH. SIMPLY 70X68X88 2/T CAISSON SIMPLY 70X68X88 2/PORTES</p>	<p>Art. 08693</p>	<p>Art. 08694</p>		<p>Art. 08695</p>
	<p>P/LAVATRICE SIMPLY 2/A 69X63X88 WASHING MACHINE CABINET SIMPLY 69X63X88 2/D WASCHMASCHINENSCH. SIMPLY 69X63X88 2/T MEUBLE POUR LAVE LINGE 2/PORTES</p>	<p>Art. 08491</p>	<p>Art. 08492</p>		<p>Art. 08494</p>
	<p>P/LAVATRICE SIMPLY 38 GIORNO – ROV NOD WASHING MACHINE CABINET SIMPLY WITHOUT/D – KNOTTED OAK WASCHMASCHINENSCH. SIMPLY OHNE/T – ASTEICHE MEUBLE POUR LAVE LINGE SANS/P - NOUEUX CHÊNE 69X63X86</p>			<p>Art. 08558</p>	

LAUNDRY

Colori - colours - Farben - couleurs				
Ⓛ	Bianco	Bianco Matrix	Rovere N.	Cemento
ⓖⓑ	White	White Matrix	Rovere N.	Cemento
ⓓ	Weiss	Weiss Matrix	Rovere N.	Cemento
ⓕ	Blanc	Blanc Matrix	Rovere N.	Cemento

	<p>P/LAV.ASC: SIMPLY 38 ROV NOD-C/TOP WASHING MACHINE CABINET SIMPLY 38 KNOTTED OAK WITH TOP WASCHMASCHINENSCH. SIMPLY 38 ASTEICHE MIT PLATTE MEUBLE POUR LAVE LINGE SIMPLY 38 NOUEUX CHÊNE AVEC PLAN</p> <p>69X63X89</p>			<p>Art. 08887</p>	
	<p>PENSILE SIMPLY 2/A 68X20X61 WALL CABINET 2/D 68X20X61 HÄNGESCHRANK SIMPLY 2/T 68X20X61 WALL CABINET 2/D 68X20X61</p>	<p>Art. 08446</p>	<p>Art. 08498</p>	<p>Art. 08499</p>	

Per lampade e specchiere, consultare da pag. 06 a pag. 29

For lamps and mirrors, see from page 09 to 29

Für Lampen und Spiegel siehe Seite 06 bis 29

Pour les lampes et les miroirs, voir à partir de page 06 à la page 29

Condizioni generali di vendita

- 1 Le commesse sia dirette che tramite agente sono sempre subordinate alla approvazione della casa venditrice. Se l'ordine non verrà accettato, l'azienda darà comunicazione scritta a mezzo fax entro quindici giorni dal ricevimento dell'ordine. Per le commesse effettuate direttamente alla casa venditrice a mezzo telefono bisogna far seguire ordine scritto via fax.
- 2 La merce viene spedita in porto franco, per importi netti inferiori a Euro 500,00 verrà addebitato un recupero spese di trasporto di Euro 50,00 anche se spedita con mezzi propri.
- 3 La merce viaggia sempre a rischio del committente anche se venduta in porto franco domicilio del cliente.
- 4 Per le consegne effettuate a mezzo corriere è tassativo il controllo del materiale al momento del ritiro; nel caso di materiale difettoso lo stesso non deve essere accettato. Le verifiche sui tops ceramica, sui tops marmo e sui tops cristallo devono essere fatte tassativamente al momento dello scarico. Non si accetteranno contestazioni successive.
- 5 Non si accettano resi se non per evidenti difetti di fabbricazione.
- 6 Nessun articolo può essere reso senza nostra preventiva autorizzazione, in tal caso i resi, anche se autorizzati, dovranno pervenirci in "conto visione" negli imballi originali in porto franco e non sarà effettuato alcun accredito, se non sarà fatto esplicito riferimento al documento di trasporto o alla fattura di vendita.
- 7 Si fa presente che i tops marmo, trattandosi di prodotti naturali, sono soggetti a variazioni di colore, intensità e tonalità delle venature.
- 8 I termini di pagamento sono i seguenti: contanti allo scarico, sconto 3%; rimesse dirette a trenta giorni sconto 2%; fatture inferiori a 500,00 Euro, ricevuta bancaria con spese a sessanta giorni; fatture superiori a 500,00 Euro ricevuta bancaria con spese a novanta giorni.
- 9 Le rimesse dirette debbono pervenirci tassativamente entro trenta giorni dalla data di fatturazione, trascorso tale termine verrà emessa tratta con spese con scadenza a vista. In caso di mancato pagamento nei termini concordati saranno applicati gli interessi al tasso ufficiale di sconto maggiorati di otto punti a titolo di penale.
- 10 I prezzi indicati sul presente listino si intendono al netto di IVA ed eventuali altri oneri.
- 11 Il presente listino annulla e sostituisce tutte le precedenti quotazioni in qualsiasi forma applicate e stabilite e può essere variato senza preavviso. Si declina ogni responsabilità per eventuali inesattezze dovute ad errori di stampa o trascrizione.
- 12 La ditta Progetto Idea Stella si riserva la facoltà di apportare tutte quelle modifiche tecniche necessarie ai fini di una migliore funzionalità senza l'obbligo di darne preavviso.
- 13 L'accettazione di nostre offerte o spedizioni implica anche l'accettazione integrale delle nostre condizioni di vendita, sopra riportate.
- 14 La vendita viene effettuata ai sensi dell'Art.1523 codice civile e seguenti, per cui la merce rimane di proprietà del venditore fino a che non viene pagato l'intero corrispettivo di vendita, il cui ammontare è riportato sulla fattura di riferimento.
- 15 Per qualsiasi controversia, unico foro competente è quello Ascoli Piceno.

General sales conditions

- 1 Orders sent directly or through the agent have always to be approved by the producer company, which decides whether to accept them or not, giving notice by fax within 15 days after the receipt of the order. Orders by telephone will be followed by a written confirmation by fax within 5 days.
- 2 Goods are delivered ex works.
- 3 The risks concerning the goods during the transport are covered by the purchaser, even if the delivery is in carriage free.
- 4 In case the delivery is performed by a carrier, a careful control of the goods at the moment of their discharge is strongly recommended; if the goods are defective they should not be accepted. The integrity of the marble tops must be verified peremptorily at the moment of their unloading. All defects must be reported on the delivery document, contesting them directly to the carrier and notifying them immediately by fax to the exporter.
- 5 Returned goods won't be accepted unless they show evident manufacturing defects.
- 6 No article will be returned without the producer's authorization. In this case the returned goods will be sent in "vision account" in their original packing, free of charge and no credit will be due if there won't be reference to the transport documentation or invoice.
- 7 Being marble tops natural products, they could differ from each other in colour, intensity and tonality, according to the vein at the moment of its cut. These differences are not accepted as claims.
- 8 Payment terms will be agreed according to the peculiarity of the situation and to the customer's demands.
- 9 The prices contained in this price-list do not include VAT.
- 10 The present price-list cancels and replaces the previous quotations and can be changed without notice. The producer company is not responsible for possible mistakes due to improper printing or transcription.
- 11 The company Progetto Idea Stella has the faculty to bring, without notice, all technical changes it feels necessary to improve the functionality of its items.
- 12 The acceptance of our offers and deliveries implies the total acceptance of our sales conditions reported above.
- 14 The sale is carried out in accordance with article 1523 of the civil code and followings, for which the goods remain property of the seller until the payment of the entire amount; the amount is shown on the invoice to which it refers.
- 15 Any dispute that may arise in connection with these conditions must be submitted to the Court of Justice of Ascoli Piceno.



PROGETTO IDEA STELLA



PROGETTO IDEA STELLA srl
Via Ottantunesima Strada, 2
63076 CENTOBUCHI (AP) - ITALY
Tel. +39 0735 705242
Fax +39 0735 705305

webmaster@ideastella.com
www.ideastella.com